

free pattern

BALOS BEACH

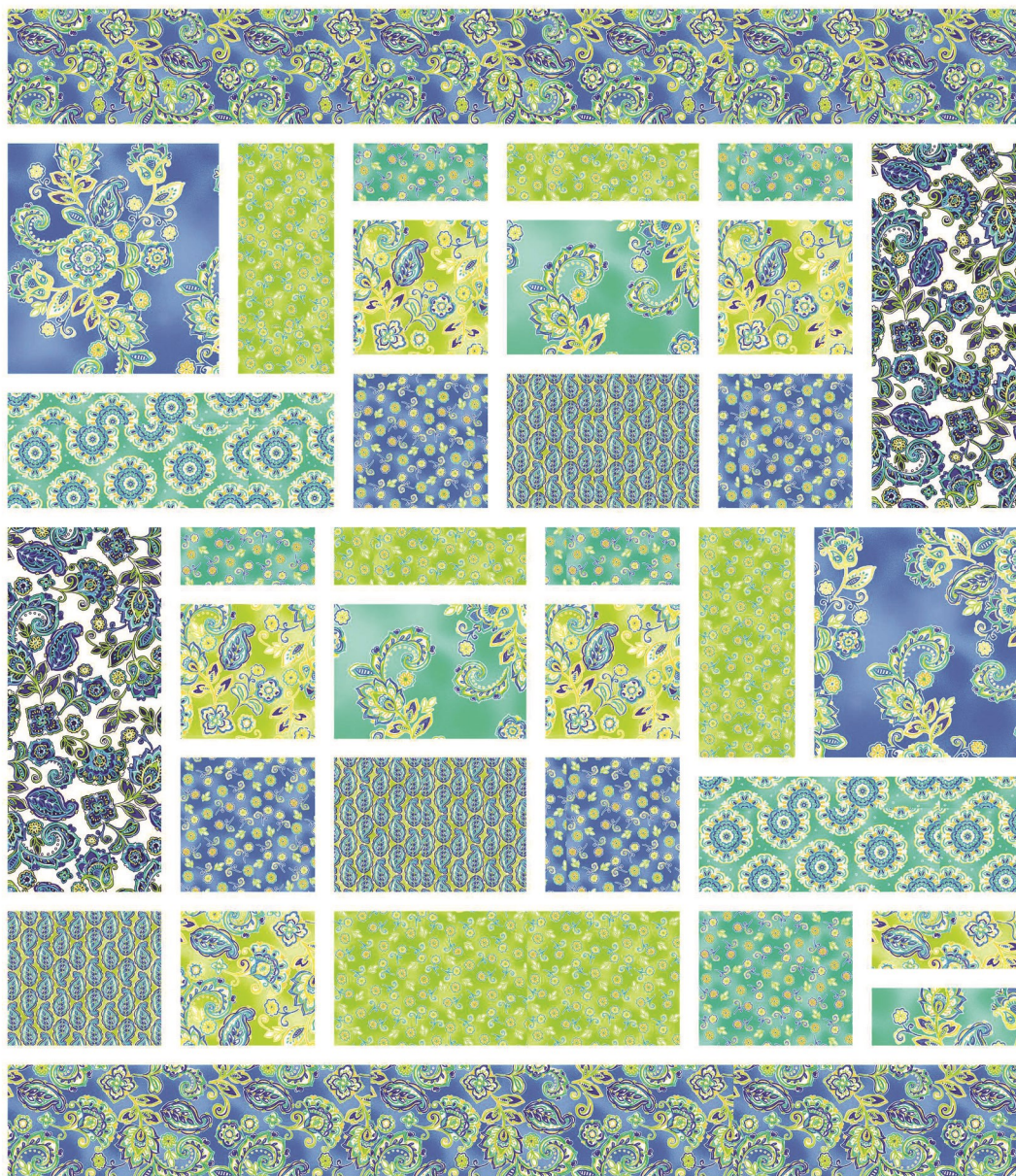









- BY BENARTEX STUDIO
- FINISHED SIZE: 55" X 65"
- PATTERN AVAILABLE IN MAY/JUNE 2021
AT WWW.BENARTEX.COM

BLUE HORIZON
by Kanvas Studio

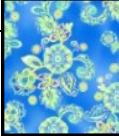
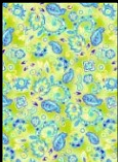
CUTTING INSTRUCTIONS

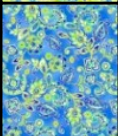
*WOF = Width of fabric / *Sew strips via short ends, then subcut as indicated in pattern*

	A HORIZON MEDALLION 9961-84 <i>Light Jade</i>	1/4 YD	(1) 6-1/2" X WOF strip, subcut (2) 6-1/2" X 19-1/2" rectangles A1		G HORIZON FLOWER BUDS 9965-50 <i>Blue</i>	1/4 YD	(1) 7-1/2" X WOF strips, subcut (4) 7-1/2" squares G1
	B HORIZON PAISLEY 9962-40 <i>Green</i>	1/4 YD	(1) 7-1-2" X WOF strip, subcut (2) 7-1/2" X 10-1/2" rectangles B1 and (1) 7-1/2" X 8-1/2" rectangle B2		H HORIZON FLOWER BUDS 9965-84 <i>Jade</i>	1/4 YD	(1) 7-1/2" X WOF strip, subcut (1) 7-1/2" X 8-1/2" rectangle H1 and (4) 3-1/2" X 7-1/2" rectangles H2
	C HORIZON JACOBEOAN 9964-09 <i>White</i>	3/8 YD	(1) 8-1/2" X WOF strip, subcut (2) 8-1/2" X 19-1/2" rectangles C1		J HORIZON BOUQUETS 9966-50 <i>Medium Blue</i>	3/8 YD	Fussy Cut: (2) 11-1/2" X 12-1/2" rectangles J1
	D HORIZON JACOBEOAN 9964-44 <i>Lime Green</i>	3/8 YD	(1) 7-1/2" X WOF strips, subcut (5) 7-1/2" squares D1 (1) 3-1/2" X WOF strip, subcut (1) 3-1/2" X 8-1/2" rectangle D2		K HORIZON BOUQUETS 9966-84 <i>Jade</i>	3/8 YD	Fussy Cut: (2) 7-1/2" X 10-1/2" rectangles K1 and (1) 3-1/2" X 8-1/2" rectangle K2
	E HORIZON JACOBEOAN 9964-50 <i>Medium Blue</i>	5/8 YD	(3) 6-1/2" X WOF strips *, BORDER		L SUPERIOR SOLIDS 3000H-09 <i>White</i>	1-5/8 YD	(11) 1-1/2" x WOF strips, subcut (2) 1-1/2" x 12-1/2" strips L1 (8) 1 1/2" x 19 1/2" strips L2 (2) 1 1/2" x 17 1/2" strips L3 (12) 1 1/2" x 7 1/2" strips L4 (4) 1 1/2" x 10 1/2" strips L5 (1) 1 1/2" x 8 1/2" strip L6 (3) 1-1/2" x WOF strips*; SIDE BORDER (5) 1-1/2" x WOF strips*; SASHING (3) 2 1/2" x WOF strips*; TOP/BOTTOM BORDER (7) 2 1/4" x WOF strips*; BINDING
	F HORIZON FLOWER BUDS 9965-44 <i>Lime Green</i>	1/2 YD	(1) 7-1/2" X WOF strip, subcut (1) 7-1/2" X 18-1/2" rectangle F1 and (2) 3-1/2" X 10-1/2" rectangles F2 (1) 5-1/2" X WOF strip, subcut (2) 5-1/2" X 12-1/2" rectangles F3				

BLOCK ASSEMBLY: Refer to **BLOCK DIAGRAMS**

1. Sew (1) **L1** strip, (1) **J1** rectangle, (1) **F3** rectangle, (1) **L2** strip and (1) **A1** rectangle together as shown to create **BLOCK 1**. Square to 19-1/2", make (1).
2. Repeat Step 1 to create **BLOCK 2**. Square to 19-1/2", make (1). *Note: **BLOCK 2** is a mirror image of **BLOCK 1**.*
3. Sew (1) **D2** rectangle, (1) **L6** strip, and (1) **K2** rectangle together as shown to create **BLOCK 3**. Square to 8-1/2" X 7-1/2", make (1).
4. Sew (2) **H2** rectangles, (2) **D1** squares, (2) **G1** squares, (1) **F2** rectangle, (1) **K1** rectangle, (1) **B1** rectangle, (4) **L4** strips, (2) **L5** strips and (2) **L2** strips together as shown to create **BLOCK 4**. Square to 26-1/2" X 19-1/2", make (2).

BLOCK DIAGRAMS

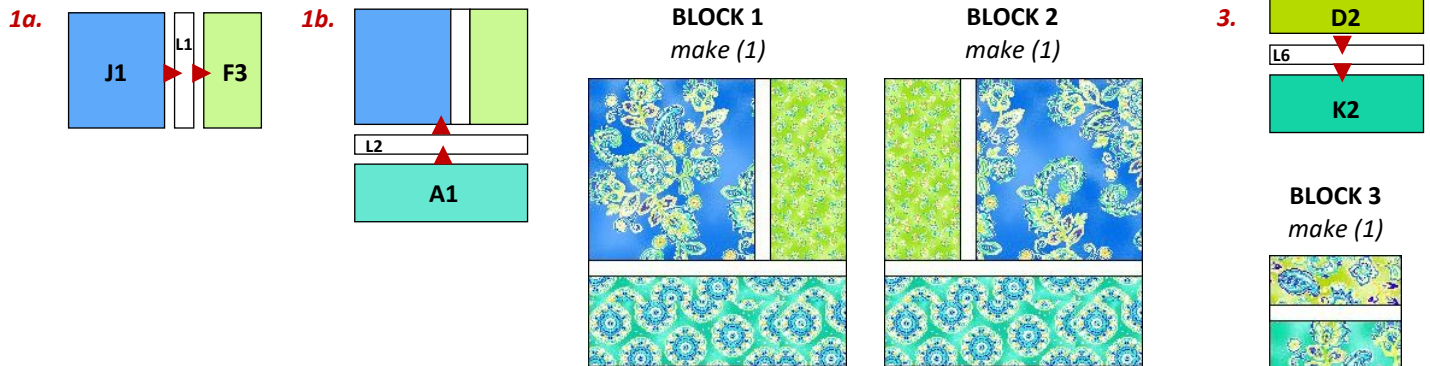

BLOCK ASSEMBLY (continued) : Refer to **BLOCK DIAGRAMS**

4. Sew (2) **H2** rectangles, (2) **D1** squares, (2) **G1** squares, (1) **F2** rectangle, (1) **K1** rectangle, (1) **B1** rectangle, (4) **L4** strips, (2) **L5** strips and (2) **L2** strips together as shown to create **BLOCK 4**. Square to 26-1/2" X 19-1/2", make (2).

BLOCK DIAGRAMS

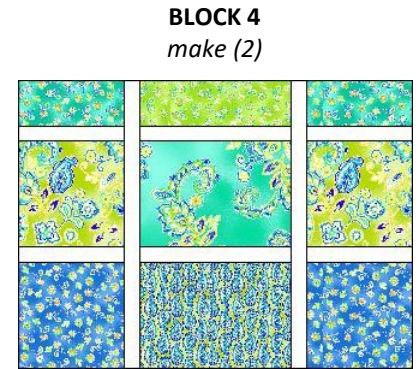
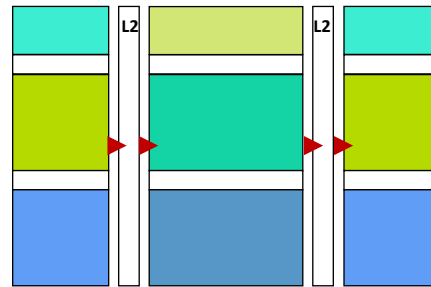
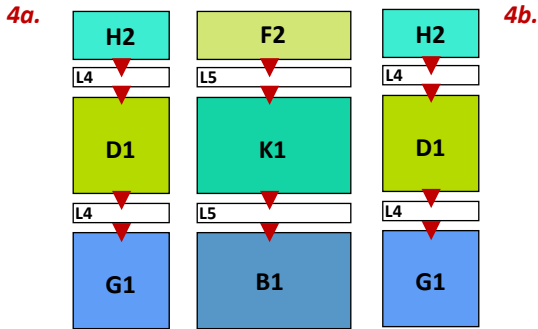

QUILT ASSEMBLY: Refer to **QUILT DIAGRAM** for proper block placement and rotation.

5. Sew blocks, strips and pieces together into pieced rows, then sew pieced rows and (4) **L** 1-1/2" X 53-1/2" sashing strips together.
- ROW 1: BLOCK 1 - L2 strip - BLOCK 4 - L2 strip - C1 rectangle
ROW 2: C1 rectangle - L2 strip - BLOCK 4 - L2 strip - BLOCK 2
ROW 3: B2 rectangle - L4 strip - D1 square - L4 strip - F1 rectangle - L4 strip - H1 rectangle - L4 strip - BLOCK 3

BORDER ASSEMBLY: Measure width and length of quilt top to ensure border cutting sizes. Below are *our measurements*.

6. Sew (1) **E** 6-1/2" X (53-1/2") strip to top and bottom.
7. Sew (1) **J** 1-1/2" X (61-1/2") strip to each side of quilt, then sew (1) **J** 2-1/2" X (55-1/2") strip to top and bottom.

FINISHING:

Cut batting and backing 3" larger than top on all sides. Layer backing, batting and top together and baste or pin. When quilting is completed, trim excess batting and backing. Bind with **L** fabric.

Note: If this Benartex pattern is included in a kit, any questions about the kit should be addressed to the vendor from whom you bought it.

Share your finished quilt with the Benartex community on social media by tagging **#benartex_fabrics**



Also visit our Sewing Group on Facebook, **Sew Interesting**

**BALOS BEACH
 QUILT DIAGRAM
 SIZE: 55" X 65"**

